

- Flexible
- Próximo
- Fiable
- Rentable

SERIE
C97





1 Marco Perimetral

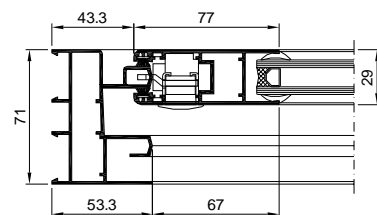

2 Nudo Central

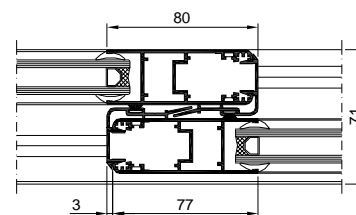

3 Marco Perimetral 3 Carriles

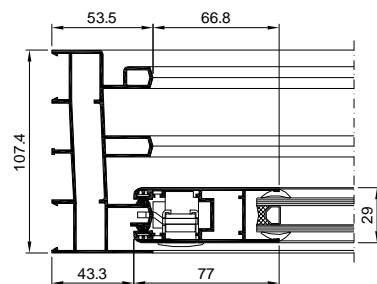

4 Cierre Central

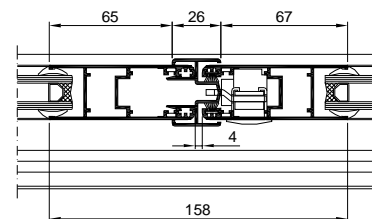

5 Marco Perimetral - Hoja 67 mm.

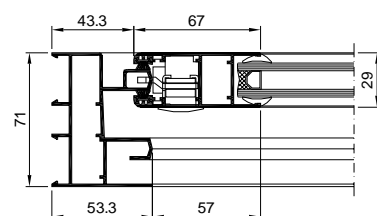

6 Marco Fijo

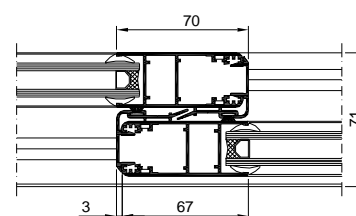

7 Marco Fijo

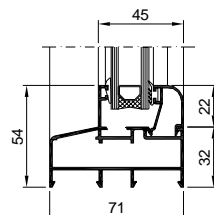

8 Parteluces

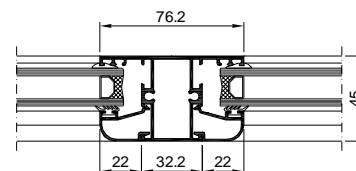

Descripción

- Carpintería corredera perimetral.
- Marco de 71 mm. y hojas de 29 mm.
- Espesor medio en marcos de 1,4 y 1,5 mm. en hojas.
- Juntas de estanqueidad mediante burletes.
- Hueco de acristalamiento entre 10 y 25 mm.

Ensayos Marcado CE

Medidas de ensayo: 1,23 x 1,48 m. = 1,82 m²

AIRE	2
AGUA	6A
VIENTO	C5
TÉRMICA	Uw = 3,1 W / m ²
ACÚSTICA	Rw = 29 (-1;-3) dBA

Transmitancia Térmica calculada para carpintería de 5,51 m² con vidrio bajo emisivo 4/16/4

Atenuación Acústica calculada para carpintería con una superficie inferior a 3,10 m²

Aperturas

Ventanas y Puertas Balconeras

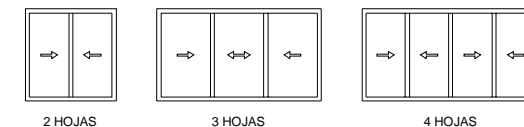

Otras Combinaciones

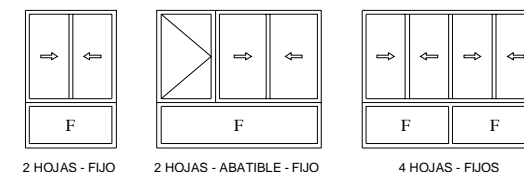

M-3950

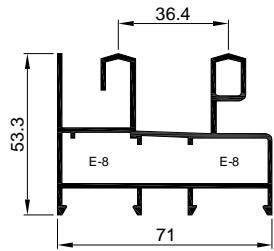

M-3952

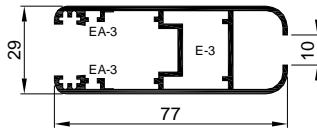

M-3953

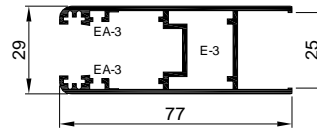

M-4456

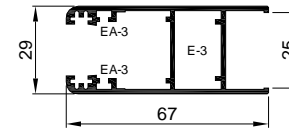

M-2620

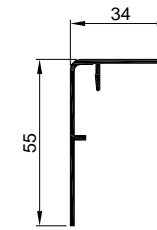

M-4049

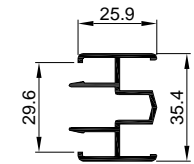

M-3955

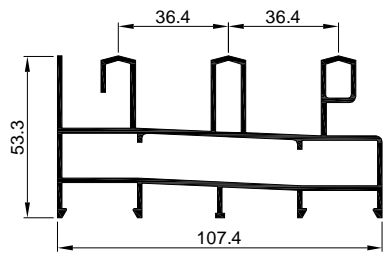

M-5342

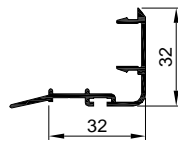

M-5343

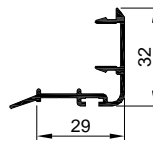

M-3951

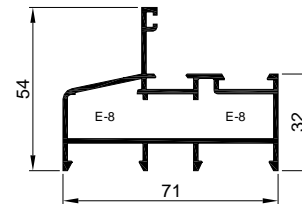

M-3204

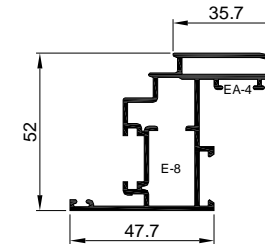

M-3393

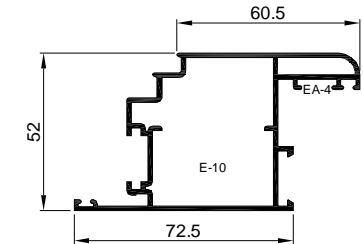

M-1997

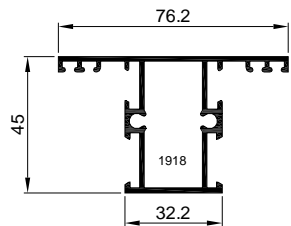

M-1999

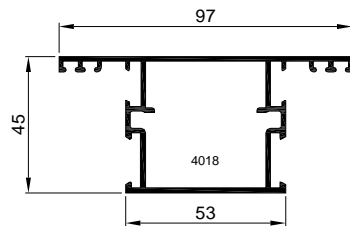

M-2594

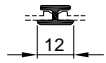

M-3079

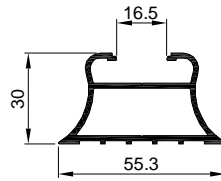

M-1249



M-3229

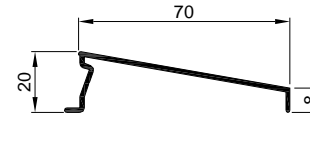

M-3230

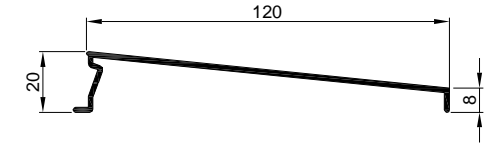

M-5292

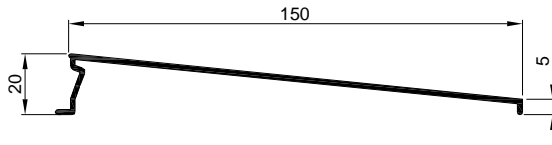



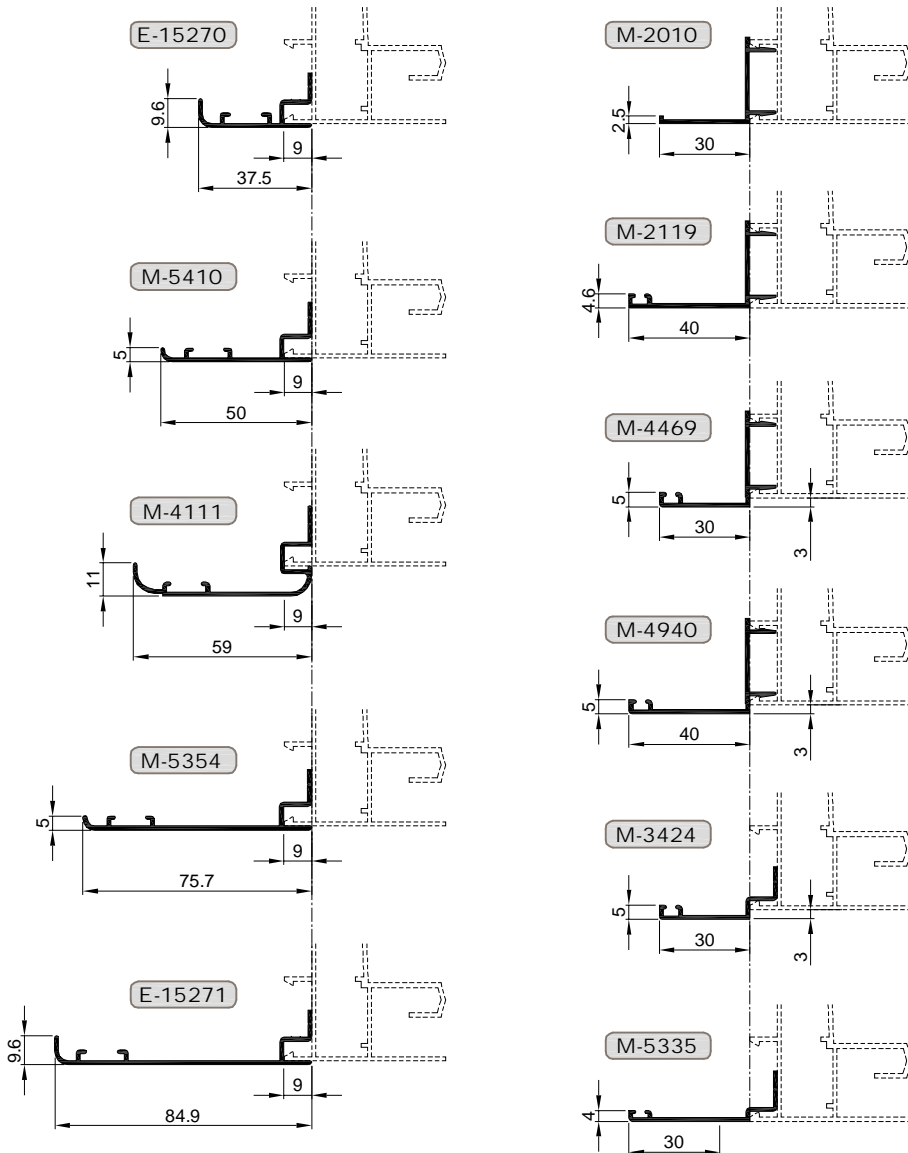



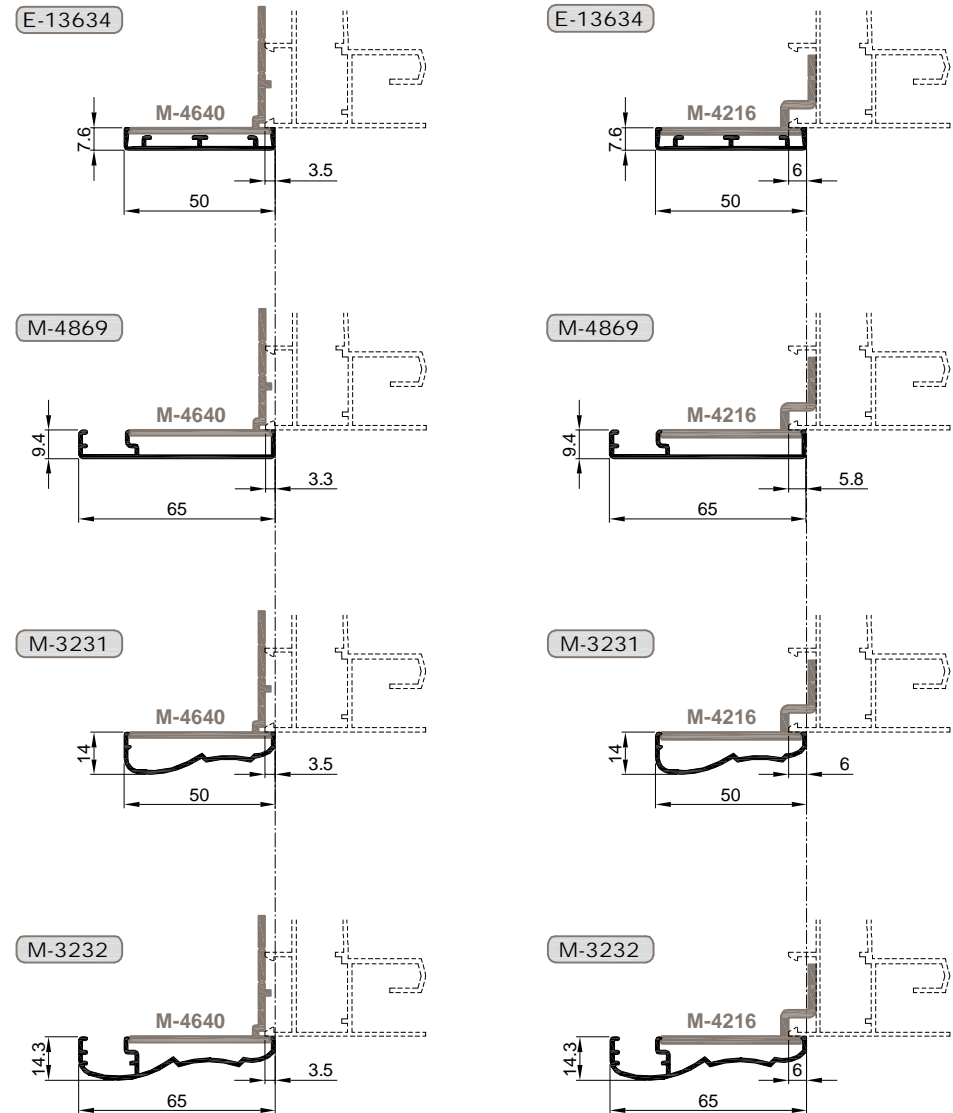

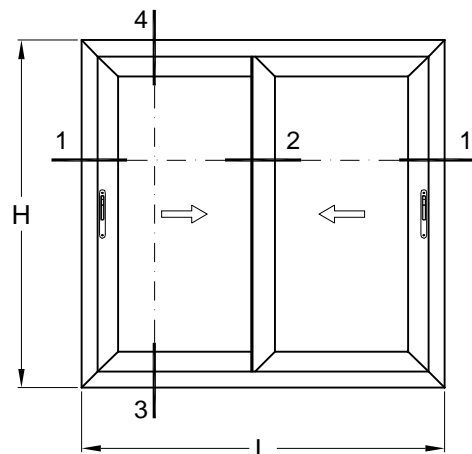
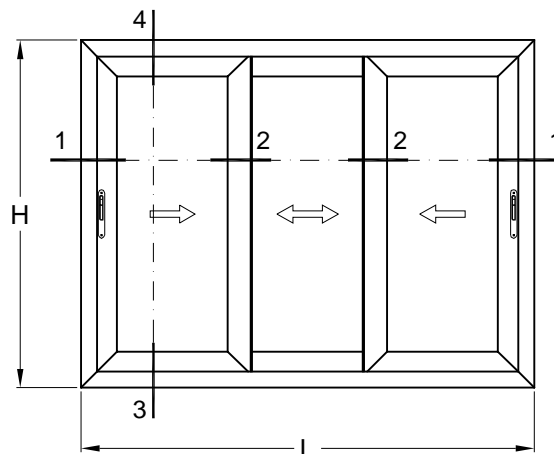
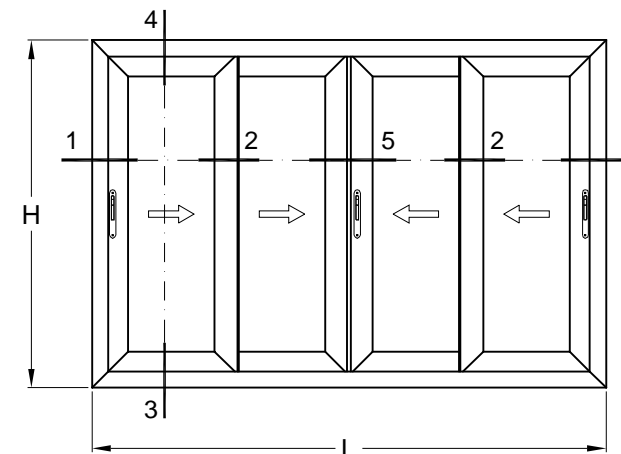
CON TORNILLO ó CLIP





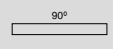



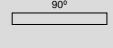



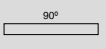



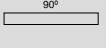

CON GRAPA

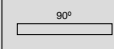

CORREDERA DE 2 HOJAS

CORREDERA DE 3 HOJAS

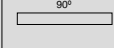
CORREDERA DE 4 HOJAS

PERFIL	Refª. / DENOMINACION	Uds. / Corte				
	M-3950 MARCO PERIMETRAL	2	L	2	H	
	M-2620 VIERTEAGUAS	1	L			
	M-3953 HOJA PERIMETRAL	4	L / 2 - 6	4	H - 86	
	M-5342 CRUCE HOJAS	2	H - 86 Con Mecanizado		H - 194 Con Tapa	

PERFIL	Refª. / DENOMINACION	Uds. / Corte				
	M-3950 MARCO PERIMETRAL	2	L	2	H	
	M-2620 VIERTEAGUAS	1	L			
	M-3953 HOJA PERIMETRAL	6	L / 3 + 20	6	H - 86	
	M-5342 CRUCE HOJAS	4	H - 86 Con Mecanizado		H - 194 Con Tapa	

PERFIL	Refª. / DENOMINACION	Uds. / Corte				
	M-3950 MARCO PERIMETRAL	2	L	2	H	
	M-2620 VIERTEAGUAS	1	L			
	M-3953 HOJA PERIMETRAL	4	L / 4 + 14	4	H - 86	
	M-5342 CRUCE HOJAS	2	H - 86 Con Mecanizado		H - 194 Con Tapa	
	M-4049 CIERRE CENTRAL	1	H - 86			

- Las medidas indicadas son orientativas. Rogamos verifiquen las mismas antes de cortar material en serie para evitar posibles errores.

Sección 1 - 1

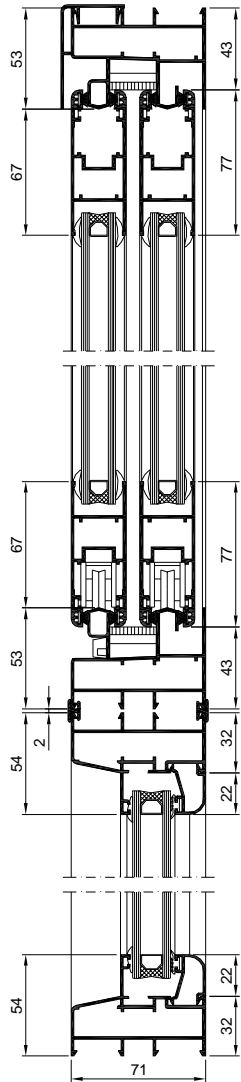

**CORREDERA DE 2 HOJAS
Y FIJO INFERIOR**

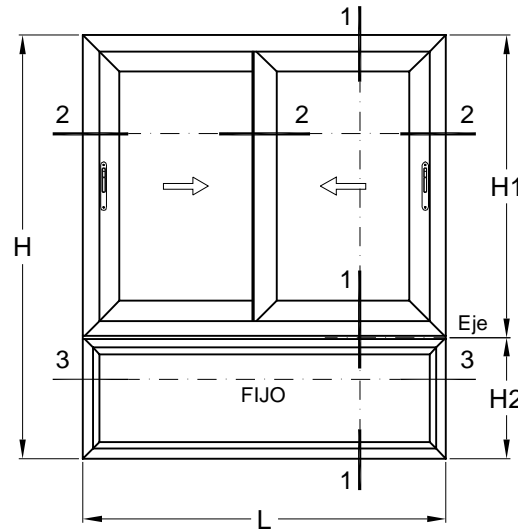

Sección 2 - 2

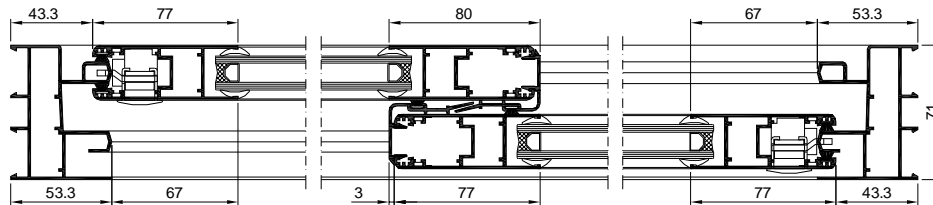

Sección 3 - 3

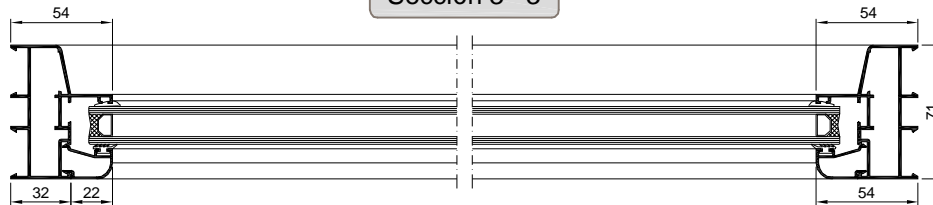

- Las medidas indicadas son orientativas. Rogamos verifiquen las mismas antes de cortar material en serie para evitar posibles errores.

PERFIL	Refª. / DENOMINACION		Uds. / Corte		
	M-3950	MARCO PERIMETRAL	2 2	L H1 -	
	M-2620	VIERTEAGUAS	1	L	
	M-3953	HOJA PERIMETRAL	4 4	L / 2 - 6 H1 - 87	
	M-5342	CRUCE HOJAS	2	H - 87 Con Mecanizado H - 195 Con Tapa	
	M-2594	UNION MARCOS	1	L	
	M-3951	MARCO FIJO	2 2	L H2 - 1	
	Ver Tabla	JUNQUILLOS	2 2	L - 64 H2 - 65	

EN PREPARACION

c/ Cormoranes, 18 Poligono Industrial La Estación
28320 - Pinto (MADRID)
Telf: 91 691 54 11 / Fax: 91 691 58 79
E-mail: extrusion.spain@sapagroup.com

SAPA y SISTEMAS EXPRAL como marca de SAPAGROUP no se hacen responsables del mal uso que se realice de los contenidos de este catalogo, siendo exclusiva responsabilidad de la persona/as que accede a ellos o los utiliza.

Tampoco asumimos ninguna responsabilidad de los errores tipográficos que puedan aparecer en este catálogo y nos reservamos el derecho de cambiar o modificar sin previo aviso su contenido cuando sea necesario.